

Miele

Operating and Installation Instructions

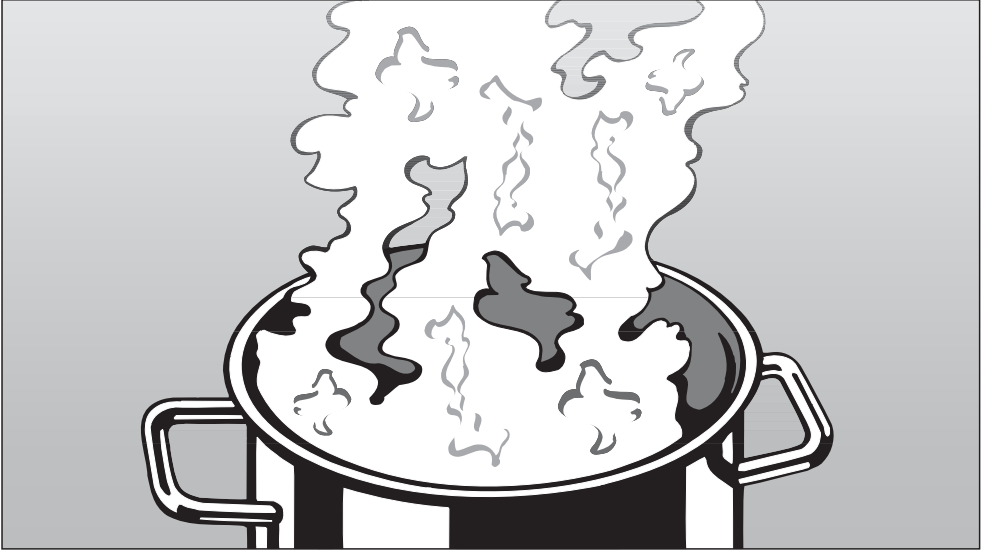

Ventilation System

DA 6590 W

DA 6520 W

To prevent accidents
and appliance damage,
read these instructions



before

installation or use.

en - US

M.-Nr. 09 523 600

Contents

IMPORTANT SAFETY INSTRUCTIONS	3
Description of functions	7
Guide to the ventilation system	8
Operation	10
Turning the fan on ①	10
Selecting the power level.	10
Intensive setting IS	10
Delayed shut down 5  15	11
Overhead lighting 	11
Filter timer 	12
Cleaning and care	14
Cleaning the casing	14
Glass or stainless steel panels and grease filters	15
Resetting the grease filter timer	17
Installing / replacing the odor-free filter	18
Resetting the odor-free filter timer	18
Changing the light bulbs	19
After Sales Service	20
Installation instructions	21
Caring for the environment	23
Appliance dimensions	24
Plywood backing	28
Installation	29
Installation instructions	29
Protective film	29
Dismantling	29
Installation material	30
Air extraction	32
Reducing Collar	34
Condensate trap	34
Electrical connection	35
Technical data	36

IMPORTANT SAFETY INSTRUCTIONS

READ AND SAVE THESE INSTRUCTIONS

Keep these instructions in a safe place and pass them on to any future user.

Read these instructions carefully before installing or using the Ventilation System.

- ▶ This appliance is intended for residential use only. Use the appliance only for its intended purpose.
- ▶ This appliance complies with current safety requirements. Improper use of the appliance can lead to personal injury and material damage.

⚠ CAUTION
For General Ventilating Use Only. Do Not Use To Exhaust Hazardous Or Explosive Materials And Vapors.

- ▶ This appliance is designed to vent cooking smoke and odors only.
- ▶ This appliance is suitable for installation above gas or electric cooking surfaces.
- ▶ This appliance is not intended for outdoor use.
- ▶ This appliance must not be used in a non-stationary location (e.g. on a ship).

⚠ WARNING
TO REDUCE THE RISK OF FIRE, ELECTRIC SHOCK, OR INJURY TO PERSONS, OBSERVE THE FOLLOWING:

- ▶ a) Use this appliance only in the manner intended by the manufacturer. If you have questions, contact Miele.
- ▶ b) Before servicing or cleaning the appliance, switch power off at the service panel and lock the service disconnecting means to prevent power from being switched on accidentally. If the service disconnecting means cannot be locked, securely fasten a prominent warning device, such as a tag, to the service panel.
- ▶ c) Be certain your appliance is properly installed and grounded by a qualified technician.
To guarantee the electrical safety of this appliance, continuity must exist between the appliance and an effective grounding system. It is imperative that this basic safety requirement be met. If there is any doubt, have the electrical system of the house checked by a qualified electrician.

IMPORTANT SAFETY INSTRUCTIONS

▶ d) Before connecting the appliance to the power supply make sure that the voltage and frequency listed on the data plate correspond with the household electrical supply. This data must correspond to prevent appliance damage. If in doubt consult a qualified electrician.

▶ e) Installation work and repairs should only be performed by a qualified technician in accordance with all applicable codes and standards. Repairs and other work by unqualified persons could be dangerous.

▶ f) Only open the housing as described in the enclosed "Installation diagram" and in the "Cleaning and care" section of this manual. Under no circumstances should any other parts of the housing be opened. Tampering with electrical connections or components and mechanical parts is highly dangerous to the user and can cause operation faults.

▶ g) Before discarding an old appliance, disconnect it from the power supply and remove the power cord to prevent hazards.

Use

WARNING **TO REDUCE THE RISK OF A COOKTOP GREASE FIRE:**

▶ a) Never leave surface units unattended at high settings. Boilovers cause smoking and greasy spillovers may ignite. Heat oils slowly on low or medium settings.

▶ b) Always turn the hood on when cooking at a high heat.

▶ c) Clean the ventilation hood frequently. Grease should not be allowed to accumulate on the fan or filter.

▶ d) Use the proper pan size. Always use cookware appropriate for the size of the cooking area.

▶ e) Do not flambé or grill with an open flame beneath the hood. Flames could be drawn up into the hood by the suction and the grease filters may catch fire.

IMPORTANT SAFETY INSTRUCTIONS

⚠ WARNING
TO REDUCE THE RISK OF INJURY TO PERSONS IN THE EVENT OF A COOKTOP GREASE FIRE, OBSERVE THE FOLLOWING*:

▶ a) **SMOTHER FLAMES** with a close fitting lid, cookie sheet, or metal tray then turn off the burner.

BE CAREFUL TO PREVENT BURNS. If the flames do not go out immediately, **EVACUATE AND CALL THE FIRE DEPARTMENT.**

▶ b) **NEVER PICK UP A FLAMING PAN** - You may be burned.

▶ c) **DO NOT USE WATER**, including wet dishcloths or towels - a violent steam explosion will result.

▶ d) Use a fire extinguisher **ONLY** if:

1) You have a class ABC extinguisher, and you know how to operate it.

2) The fire is small and contained in the area where it started.

3) The fire department is being called.

4) You can fight the fire with your back to an exit.

* Based on "Kitchen Firesafety Tips" published by NAFTA

▶ Do not allow children to play with or operate the appliance or its controls. Supervise its use by the elderly or infirm.

▶ Always turn on the hood when using the cooktop to prevent damage from condensation.

▶ Never operate gas burners without cookware. Turn the burner off when not in use. Adjust the burner so that the flames do not extend beneath the cookware. Do not overheat the cookware, e.g. when using a wok. The hood can be damaged due to excessive heat from the burners and the cookware.

▶ Do not use the hood without the grease filters in place.

▶ Do not use a steam cleaner to clean the hood. Steam could penetrate electrical components and cause a short circuit.

IMPORTANT SAFETY INSTRUCTIONS

Installation

⚠ WARNING
TO REDUCE THE RISK OF
FIRE, ELECTRIC SHOCK, OR
INJURY TO PERSONS,
OBSERVE THE FOLLOWING:

- ▶ a) Installation work and electrical wiring must be done by qualified person(s) in accordance with all applicable codes and standards, including fire-rated construction.
- ▶ b) Sufficient air is needed for combustion and exhausting of gases through the flue (chimney of fuel burning equipment to prevent back drafting. Follow the heating equipment manufacturer's guideline and safety standards such as those published by the National Fire Protection Association (NFPA) and the American Society for Heating, Refrigeration and Air Conditioning Engineers (ASHRAE), and the local code authorities.
- ▶ c) When cutting or drilling into the wall or ceiling, do not damage electrical wiring and other hidden utilities.
- ▶ d) Ducted hoods must always be vented to the outdoors.
- ▶ e) Do not use this hood with any solid-state speed control device.
- ▶ f) Do not use an extension cord to connect the appliance to electricity. Extension cords do not guarantee the required safety of the appliance, (e.g. danger of overheating).

▶ g) Do not install this hood over cooktops that burn solid fuel.

▶ h) Provided a larger distance is not given by the manufacturer of the cooktop, follow the minimum safety distances between a cooktop and the bottom of the hood given in the "Appliance dimensions" section of this manual.

If local building codes require a greater safety distance, follow their requirement.

If there is more than one appliance beneath the hood and they have different minimum safety distances always select the greater distance.

▶ i) Never connect an exhaust hood to an active chimney, dryer vent, vent flue, or room ventilating ductwork.

▶ j) Seek professional advice before connecting an exhaust hood vent to an existing, inactive chimney or vent flue.

▶ k) Any fittings, sealant, or materials used to install the ductwork must be made of approved non-flammable materials.

⚠ WARNING
TO REDUCE THE RISK OF
FIRE USE ONLY METAL
DUCTWORK.

Description of functions

The ventilation system can be operated

Air extraction

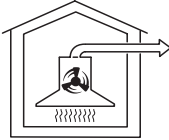

The air is drawn in and cleaned by the grease filters and directed outside.

The hood comes equipped with a **non-return flap**. This flap automatically closes when the hood is turned off so that no exchange of outside air and room air can occur. When the hood is turned on, the air pressure of the exhaust fan automatically opens the flap blowing the inside air and cooking odors outside.

Recirculation mode



The recirculation mode requires a conversion kit and odor-free filter (optional accessories for the DA 6590 W only, see "Technical data")

Air is drawn in and cleaned by the glass or stainless steel panels, grease filters as well as an **odor-free filter**. The filtered air is then recirculated back into the kitchen through a vent at the top of the hood's chimney.

In air recirculation mode, please ensure that the odor-free filter is in place, see "Cleaning and care".

Guide to the ventilation system

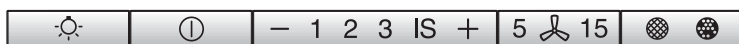
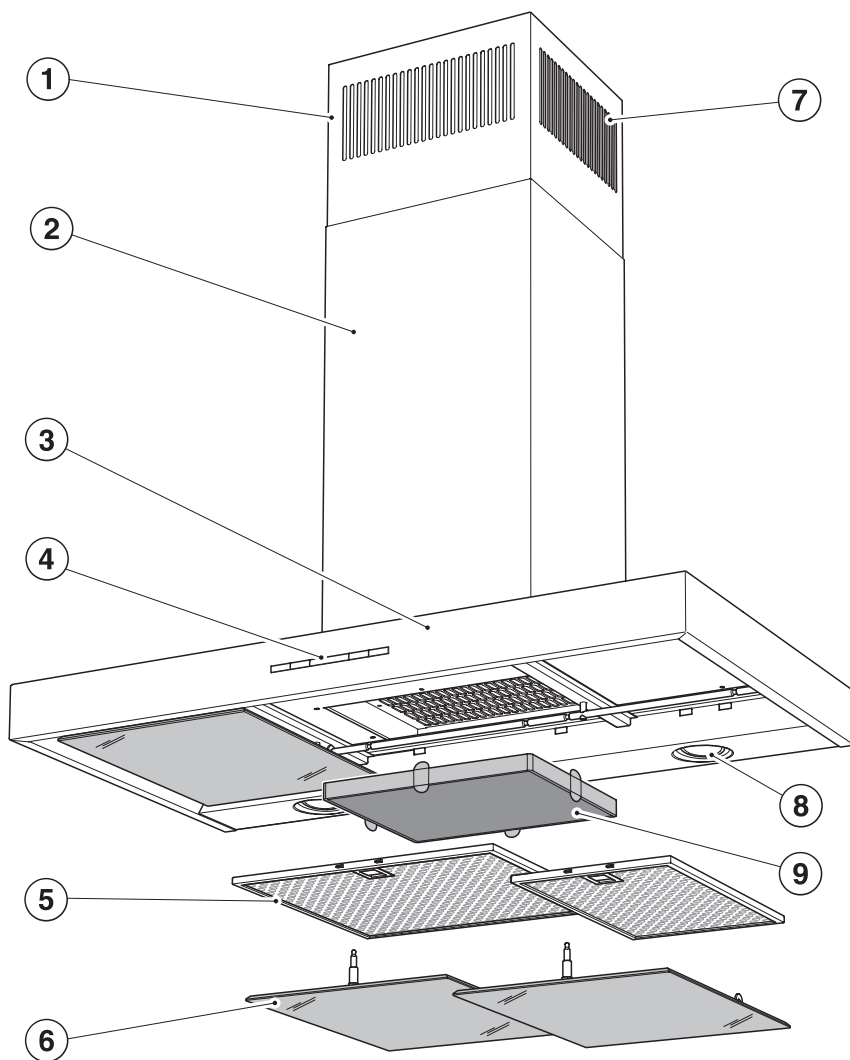

10

11

12

13

14

Guide to the ventilation system

① Chimney extension

② Chimney

③ Canopy

④ Control panel

⑤ Grease filter

⑥ Glass or stainless steel panels

Optional accessories

DRP 6590 W glass (3 elements)

DRP 6590 W stainless steel
(3 elements)

⑦ Recirculation vent

(only for the DA 6590 W in recirculation mode)

⑧ Overhead lighting

⑨ Odor-free filter

Optional accessory for recirculation mode (DA 6590 W only)

⑩ On/Off button for the overhead lighting

This button turns the light on and off and also dims it.

⑪ On/Off button

⑫ Fan power selection

⑬ Delayed shut down

This button activates the Delayed Shut Down feature. The fan can be set to turn off automatically after either 5 or 15 minutes.

⑭ Filter button

The indicator  of the grease filter button lights when the grease filters need to be cleaned.

The odor-free filter symbol  comes on when the odor-free filter (for recirculation mode) needs to be replaced. When first using the system, the operating hours timer must be activated.

This button can be used at any time to reset the respective timer after cleaning the grease filter or changing the odor-free filter (see "Cleaning and care").

You can also check the operating hours and change the setting.

Operation

Turning the fan on ①

- Press the On/Off button ①.

The fan turns on at level **2**. The ① symbol and power level **2** indicators light up.

Selecting the power level

- Use the "-/+ " controls to select the desired power level.

+ = increases the fan speed

- = decreases the fan speed



Levels "1" to "3" are usually sufficient for normal cooking.

Intensive setting IS

The **IS** level should be used temporarily for a short period of time when frying or cooking food with a strong aroma.

Automatically switching back from the IS setting

The intensive level can be programmed to automatically switch back to level **3** after 10 minutes.

- Turn the fan and the lights off.
- Press and hold the delayed shut down button **5**  **15** for approx. 10 seconds until power level **1** lights up.
- Then press the following buttons one after another:
 - overhead lighting ,
 - the - button, and
 - the overhead lighting button  again.

If the indicators **1** and **IS** flash, automatic switch-back is not activated.

- To activate automatic switch-back, press the + button. Power level indicators **1** and **IS** come on. To deactivate, press the - button.
- To save the setting, press the delayed shut-off button **5**  **15**.



If the procedure is not stored within 4 minutes of programming, the hood will automatically default to the "old" data.



Delayed shut down 5 15

For both air extraction and recirculation, it is recommended that run the fan for several minutes after cooking is completed.

This helps clear the kitchen air of any remaining vapors and odors.

The Delayed Shut Down feature can be selected to turn the fan off automatically after a preselected length of time.

- After cooking, and with the fan on, press the Delayed Shut Down button **5 15** :
 - once: the fan automatically turns off after 5 minutes (**5 15** lights up).
 - twice: the fan automatically turns off after 15 minutes (**15** lights up).

If you press the Delayed Shut Down button **5 15** again, the fan will not turn off automatically (**5 15** goes out).

Turning off the fan

- Press the On/Off button to turn the fan off .

The  indicator goes out.

Overhead lighting

Turning the overhead lighting on

The overhead lighting and the fan can be turned on and off separately.



- Press the light button  briefly to turn the light on.

The  indicator comes on.

The overhead light comes on at maximum brightness.

Dimming the overhead lighting

The brightness of the light can be adjusted.

- While the light is turned on, press and hold the light button . The light dims until the button is released.
- If the button  is pressed and held down again, the light brightens until the button is released.

If the  button is pressed continuously, the light cycles between light and dark.

Turning the overhead light off

- Briefly press the light button  to turn the light off.

The  indicator goes out.

Operation



Automatic safety shut-off

The fan will turn automatically off 10 hours of use. The lighting however will remain on.

- Press the On/Off button  to turn the fan back on again.

Filter timer

A timer counts the hours of fan operation.

The timer signals that the filters need to be cleaned or replaced by turning on the grease filter symbol  or the odor-free filter symbol .





See "Cleaning and care" for information on cleaning and replacing filters and resetting the timers.

Reprogramming the grease filter timer [

The timer may be set to suit your cooking habits.

- If you often roast and fry foods, choose a shorter operating time.
- If you tend to cook fat-free, choose a longer operating time.
- If you cook only occasionally, it is better to choose a shorter operating time. This is because accumulated grease will harden over time, making cleaning difficult.



The factory setting for the grease filter timer is 30 hours. You can adjust the time to 20, 30, 40 or 50 hours.

- Press the On/Off button  to turn the fan off
- Press the delayed shut down button **5**  **15** and the filter button   at the same time.

The grease filter symbol  of the filter button and one of the power level indicators flash.

The **1** to **IS** indicators show the programmed time:

Indicator 1	20 hours
Indicator 2	30 hours
Indicator 3	40 hours
Indicator IS	50 hours.

- Press **-** to select a shorter operating time or **+** for a longer one.
- Save the setting by pressing the filter button  .

All the lights will go out.

If the procedure is not stored within 4 minutes, the hood will automatically default to the original setting.

Activating/changing the odor-free filter timer

(in recirculation mode)

The odor-free filter is necessary for recirculation mode.

The odor-free filter timer is **not pre-set**.

The timer may be set to suit your cooking habits.

- Press the On/Off button  to turn the fan off
- Press + and the filter button — at the same time.

The odor-free filter symbol  of the timer button and one of the power level indicators flash.

The **1 to IS** indicators show the programmed time:

Indicator 1	120 hours
Indicator 2	180 hours
Indicator 3	240 hours
Indicator IS	deactivated.





- Press – to select a shorter operating time or + for a longer one.
- Save the setting by pressing the filter button .

All the indicator lights go out.

If the procedure is not stored within 4 minutes, the hood will automatically default to the original setting.

Checking the filter operating hours counter

Even before the maximum operating time has been reached, you can check what percentage of the time has elapsed.

- Press the On/Off button  to turn the fan on.
- Press the filter button  –
 - once, to check the grease filter operating time. The grease filter symbol  comes on.
 - twice, to check the odor-free filter operating time. The odor-free filter symbol  comes on.

At the same time one or more power level indicators start flashing.

The number of flashing indicators shows the elapsed operating time:

Indicator 1	25%
Indicators 1 and 2	50%
Indicators 1 to 3	75%
Indicators 1 to IS	100%

This information will remain stored in memory in the event of a power failure.

Cleaning and care

⚠ WARNING
TO REDUCE THE RISK OF
FIRE, ELECTRIC SHOCK, OR
INJURY TO PERSONS,
OBSERVE THE FOLLOWING:

Before cleaning or servicing the hood, disconnect it from the power supply, see "Important Safety Instructions".

⚠ The halogen bulbs are very hot when in use. They stay hot for some time after turned off. Use caution, danger of burns.
Wet cleaning the hot bulbs will cause damage.
Wait a few minutes after turning them off before cleaning.

Cleaning the casing

Never use abrasive cleaners, scouring pads, steel wool or caustic (oven) cleaners on the hood. They **will** damage the surface.

- All external surfaces and controls can be cleaned with a mild solution of warm water and liquid dish soap applied with a soft sponge.

Do not use too much water when cleaning the controls. Water could penetrate the electronics and cause damage.

- Wipe dry using a soft cloth.

Avoid:

- cleaning agents containing soda, acids or chlorides,
- abrasive cleaning agents e.g. powder or cream cleansers,
- abrasive sponges, e.g. pot scourers or sponges which have been previously used with abrasive cleaning agents.
- sharp metal scrapers,
- oven spray.

Special instructions for stainless steel surfaces

(not applicable to the controls)

Stainless steel surfaces can be cleaned using a non-abrasive stainless steel cleaner.

To help prevent resoiling, a conditioner for stainless steel can be applied.

Special instructions for colored casings (RAL)

(Special order)

It is very difficult to clean this type of surface without causing minor marks to the surface material. This can become particularly noticeable with darker colors and if there is halogen lighting in the kitchen.

Special instructions for glass surfaces

- Glass surfaces should be cleaned with a normal glass cleaner.

Stainless steel colored controls

These controls may become discolored or damaged if not cleaned regularly.

Do not use a stainless steel cleaner on these controls.

Glass or stainless steel panels and grease filters

The glass or stainless steel panels and the reusable metal grease filters remove solid particles from the vented kitchen air (grease, dust, etc.) and prevent soiling of the hood.

Clean the panels and grease filters at the latest when the grease filter symbol  of the timer button comes on.

The grease filters should be cleaned every 3 - 4 weeks, as the collected grease hardens over time and makes cleaning more difficult.

 A dirty filter is a fire hazard!

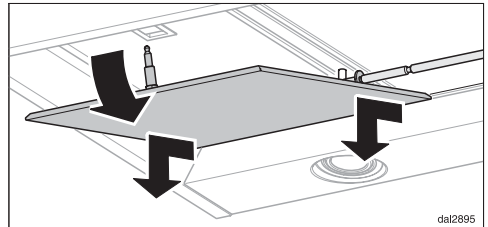

- Pull the front edge of the panels down out of the lock, lower them slightly, unhook them at the back, and take them out.

Support the panel so that it does not fall and damage the cooktop.

Cleaning and care

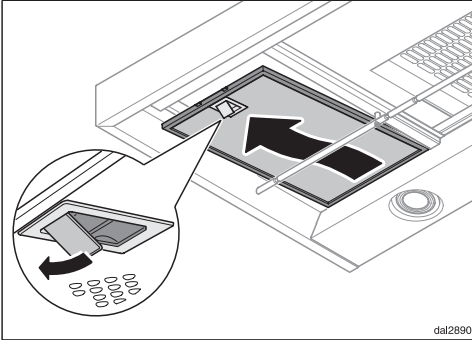

- Open the grease filter lock, lower the grease filter slightly, unhook it at the back, and take it out.

Support the grease filter so that it does not fall and damage the cooktop.

Cleaning the panels by hand

- Follow the instructions under "Cleaning the casing".

Cleaning the grease filters by hand

- Use a scrub brush with a solution of warm water and mild dish soap. Do not use the pure detergent, aggressive all purpose cleaners, oven sprays, abrasive cleaning agents or limescale removers. They could damage the filter.

Cleaning the grease filters and panels in the dishwasher

- Place the filters vertically in the lower basket, making sure that the spray arm is not blocked. Use a wash program with a max. temperature of 150°F (65°C). In a Miele dishwasher use the "Normal" program. Use the recommended amount of dishwasher detergent. Overuse could destroy the filter.

Depending on the detergent, cleaning the grease filters in a dishwasher may cause permanent discoloration of the filter surface. Filter performance will not be affected by this discoloration.

- After cleaning, place the filters on a towel to dry.
- While the panels and the filters are removed, clean any dirt or grease from the casing parts that are accessible. This reduces the risk of fire.

- When reinstalling the grease filters, make sure that the locking clips are facing down.

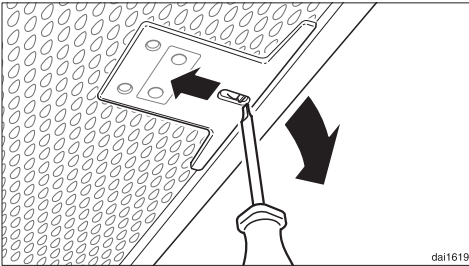

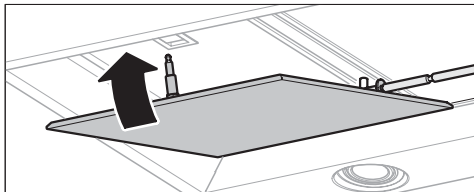
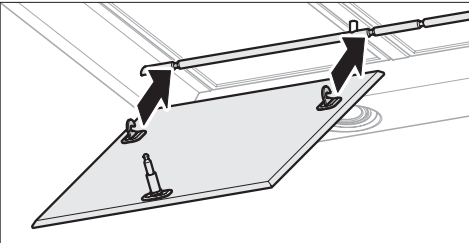

- If the filters are incorrectly installed, insert a small screwdriver into the slit along its edge to disengage them from the casing.



- Hook the panels onto the support ledge.
- Lift up the front of the panels and push them into the lock until they engage.

Resetting the grease filter timer

After cleaning, reset the grease filter timer.

- With the fan running, press and hold the grease filter button  for approx. 3 seconds, until only the **1** is flashing. The indicator light  will go out.

If the grease filters are cleaned **before** the timer has reached its maximum:

- Press and hold the grease filter button  for approx. 6 seconds, until only the **1** is flashing.

Cleaning and care

Installing / replacing the odor-free filter

In recirculation mode, an odor-free filter must be used in addition to the grease filters. It is designed to absorb cooking odors.

It is installed in the canopy above the grease filters.

Replacement active charcoal filters can be ordered from Miele.

- To install or replace the odor-free filter, the grease filters must first be removed as described in the previous pages.
- Remove the odor-free filter from the packaging.

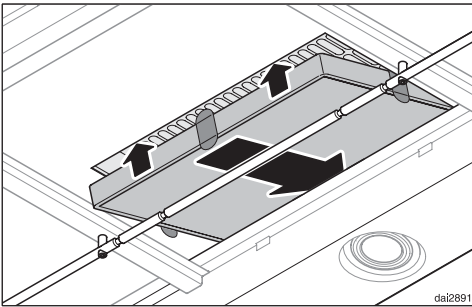

- Slide the odor-free filter into the rear of the filter frame, then raise the front and push it into the frame.
- Reinsert the grease filters and the panels.

Before first use:

- Program the filter timer (see "Operation").

Replace the odor-free filter when:

- the odor-free filter symbol  of the filter button comes on,

or



- when the filter no longer absorbs odors efficiently.

However, it should be changed at least every 6 months.

Used odor filters may be discarded with the household garbage.

Resetting the odor-free filter timer

After replacing the filter, reset the odor-free filter operating hours counter.

- With the fan running, press the filter button  **twice** and hold it for about 3 seconds, until only the **1** flashes. The odor-free filter symbol  goes out.

If you clean the odor-free filter **before** the operating time elapses:

- Press the filter button  **twice** and hold it for about 6 seconds, until only the **1** flashes.

Changing the light bulbs

⚠ WARNING
TO REDUCE THE RISK OF
FIRE, ELECTRIC SHOCK, OR
INJURY TO PERSONS,
OBSERVE THE FOLLOWING:

Before changing the light bulbs, disconnect the hood from the power supply, see "Important Safety Instructions".

When in use halogen bulbs become extremely hot, and can burn your hands. Do not attempt to change the bulbs until they have had sufficient time to cool.

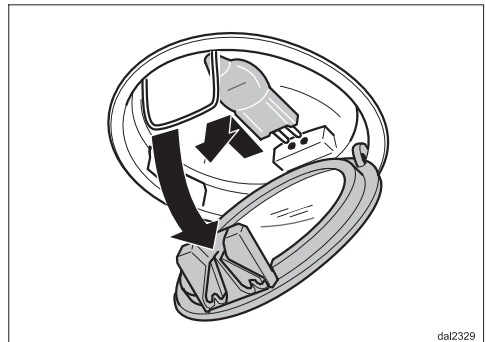
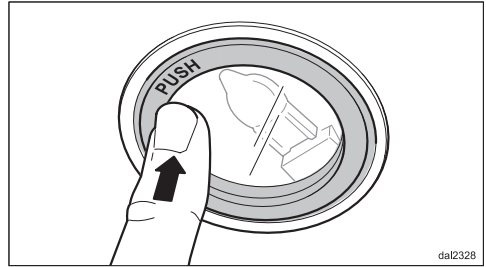

- To change the halogen bulb, first gently press the light cover. The cover will open and can now be flipped down.
- Pull the halogen bulb from its socket.
- Using a cloth or glove, insert the new halogen bulb (type 12 V, 20 W, G4).

Please follow the manufacturer's instructions.

- Flip the light cover back up, making sure it clicks into place.

After Sales Service

Repairs

In the event of a fault which you cannot easily fix yourself, please contact the Miele Technical Service Department.

- When contacting the Technical Service Department, please quote the model and serial number of your appliance.

These are shown on the data plate which is visible when the grease filters are removed.

MieleCare

(USA only)

MieleCare, our Extended Service Contract program, gives you the assurance of knowing that your appliance investment is covered by 5 years of worry free ownership.

MieleCare is the only Extended Service Contract in the industry that guarantees repairs by a Miele Authorized Service Provider using genuine Miele parts. Only genuine Miele parts installed by factory trained professionals can guarantee the safety, reliability, and longevity of your Miele appliance.

Please note that unless expressly approved in writing by Miele's Service department, Extended Service Contracts offered by other providers for Miele products will not be recognized by Miele. Our goal is to prevent unauthorized (and untrained) service personnel from working on your Miele products, possibly doing further damage to them, you and/or your home.

To learn more about **MieleCare** Extended Service Contracts, please contact your appliance dealer or visit us online at:

<http://mieleusa.com/mielecare>

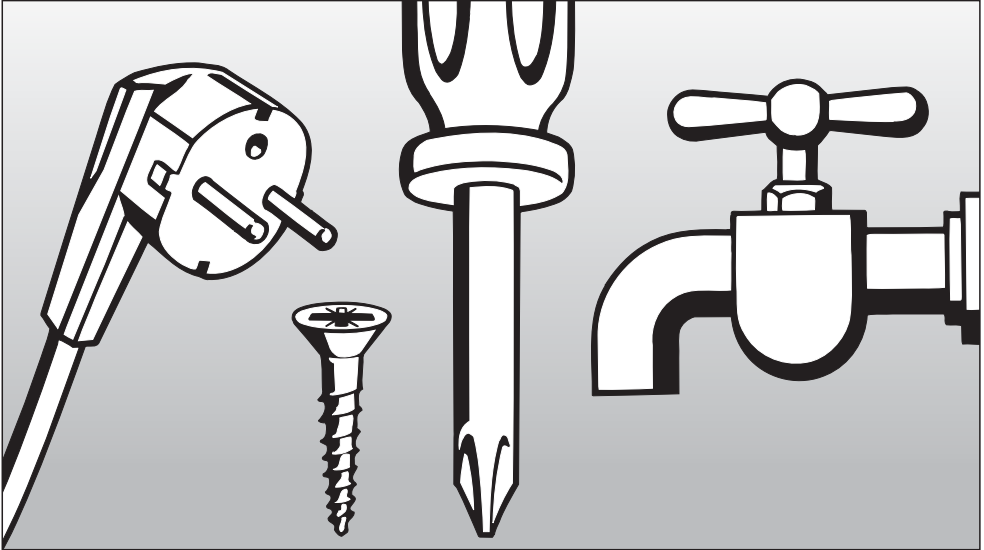

Installation Instructions

Read these instructions and the "Important Safety Instructions" before installing this ventilation system.

The installation steps are described in the enclosed "Installation Diagram".

Leave these instructions with the appliance for the consumer/user.

Information is subject to change. Please refer to our website to obtain the most current product specification, technical & warranty information.

Disposal of packing material

The cardboard box and packing materials protect the appliance during shipping. They have been designed to be biodegradable and recyclable. Please recycle.



DANGER

Ensure that any plastic wrappings, bags, etc., are disposed of safely and kept out of the reach of babies and young children. Danger of suffocation!

Disposal of an old appliance

Old appliances may contain materials that can be recycled. Please contact your local recycling center about the possibility of recycling these materials.

Before discarding an old appliance, disconnect it from the electrical supply and cut off the power cord to prevent it from becoming a hazard.

Appliance dimensions

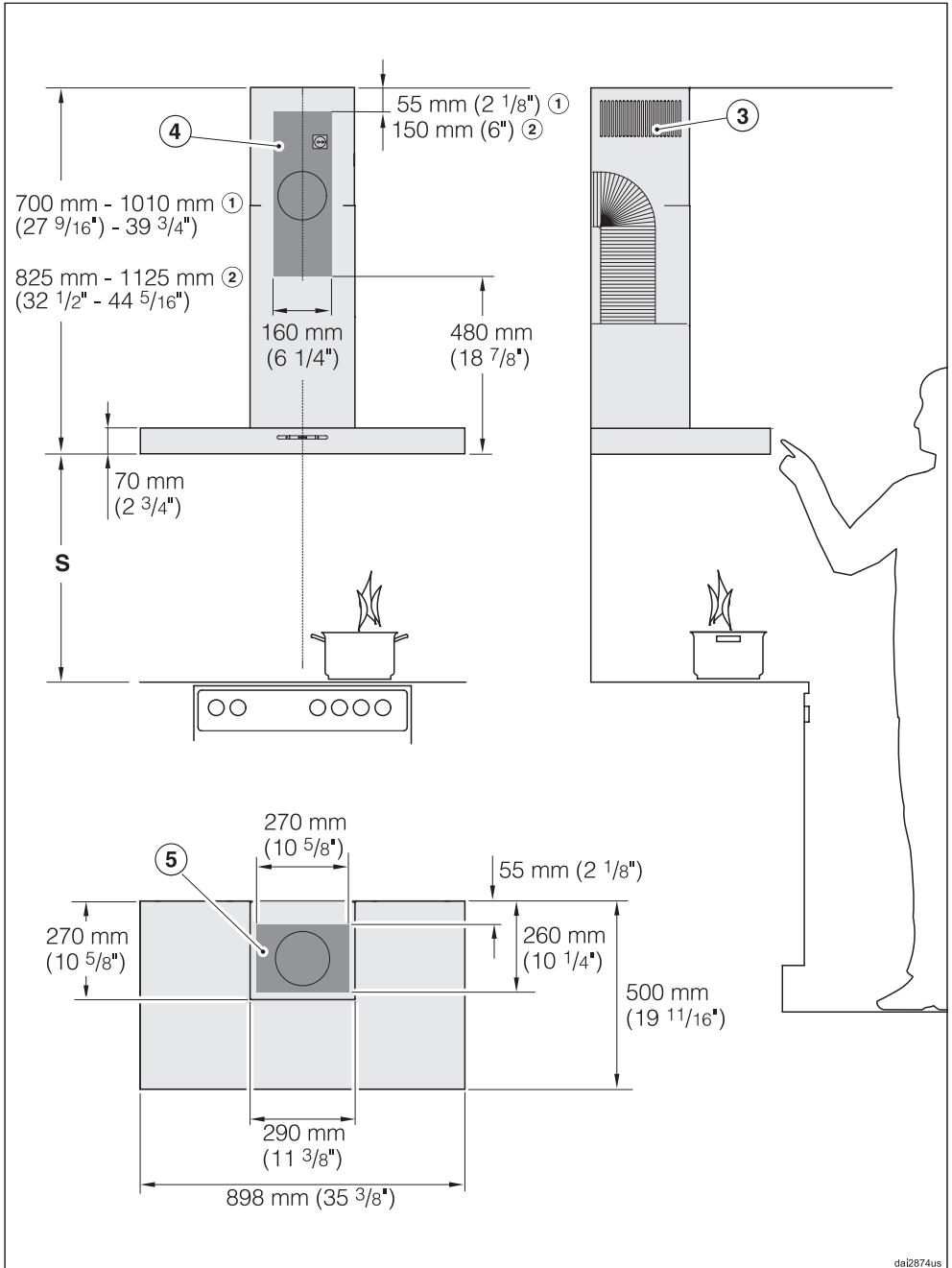

dai2874us

Drawing is not to scale.

- ① Air extraction mode
- ② Recirculation mode
- ③ Recirculation vent positioned at the top (only for the DA 6590 W in recirculation mode)
- ④, ⑤ Installation area;
For recirculation mode only ④.
Wall/ceiling area respectively for vent hole and outlet installation.
For recirculation mode only the outlet installation is required.

Connection for extraction mode

6" (150 mm), with vent pipe adapter
5" (125 mm).

Appliance dimensions

Distance between cooktop and hood (S)

Do not install this exhaust hood over cooktops burning solid fuel.

Provided a larger distance is not given by the manufacturer of the cooktop, follow the minimum safety distances between a cooktop and the bottom of the hood:

	Miele Cooktops	Non-Miele Cooktops
Electric Cooktops	24" (610 mm)	
Electric Barbeques and Fryers	26" (660 mm)	
Multiburner Gas cooktops ≤ 43,000 BTU (12.6 KW) and no burner > 15,000 BTU (4.5 KW)	26" (660 mm)	30" (760 mm)
Single burner (Wok) ≤ 20,500 BTU (6 KW)	26" (660 mm)	30" (760 mm)
All other gas cooktops	30" (760 mm)	

- If several gas surfaces are installed under the hood, the total output must be considered when determining the minimum safety distance.
- Be sure to follow the minimum safety distances given by the gas cooktop manufacturer to easily flammable materials e.g. upper cabinets.
- If local building codes require a greater safety distance, follow their requirement.
- If there is more than one appliance beneath the hood and they have different minimum safety distances always select the greater distance.

See "Important Safety Instructions" for further information.

- To ensure free access to work under the ventilation hood, a distance of a minimum of 26" (660 mm) above the electric cooktop is also recommended.
- Take the user's body height into consideration when selecting the installation height. Adequate work space at the cooktop and optimal operation of the ventilation system should be ensured.
- However, the greater the distance from the cooktop, the less effectively cooking odors are drawn in.
- If the top of the hood will be mounted flush to the ceiling, regard the possible unit height when selecting the installation height.

Drilling diagram

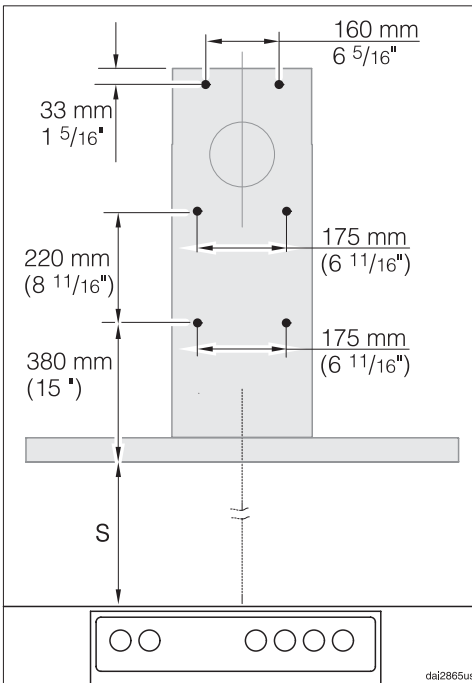

To prepare a backing plate, the spacings for the 5 mm screws need to be drilled as shown.

If the ventilation hood will be mounted directly to the wall, follow the additional instructions given in the included "Installation diagram".

Plywood backing

The majority of the weight of the installed ventilation system will be supported by the lower retaining plate. It must be firmly attached to the stud framing **behind** the drywall. If studs are not available in the required locations, a plywood backing (min. 1/2" (13 mm) thick) spanning at least two studs **must** be installed. Failure to adequately support the weight as stated may result in the ventilation system falling off the wall, causing personal injury and property damage.

(If plywood backing is not needed, proceed to the included "Installation diagram".)

To install a plywood backing

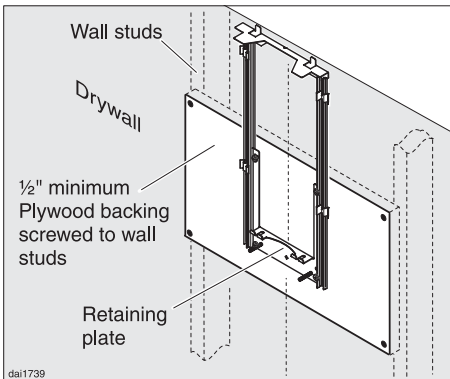

- Determine and mark the location of the retaining plate for the canopy as outlined on the "Installation diagram".
- Make a cutting line 3" (76 mm) above and 3" (76 mm) below the outline of the retaining plate.

- Find the studs to the left and right of the mounting location by tapping the wall or using a stud finder.
- Mark a vertical cutting line along the center of each stud.

CAUTION

When cutting or drilling into the wall or ceiling, do not damage electrical wiring and other hidden utilities.

- Remove the drywall between the cutting lines and replace it with plywood of a matching thickness (min. 1/2" (13 mm) thick). Tape the joints and refinish the wall.
- Proceed to the enclosed "Installation diagram" to complete the installation.

Before installation read the information in the "Dimensions" and "Important Safety Instruction" chapters.

Under certain conditions, there is a danger of poisonous fumes by when the ventilation system and a furnace drawing interior air run at the same time.

Installation instructions

The individual installation steps are described in the included Installation diagram.

Protective film

(stainless steel units)

The casing is covered with a protective film to prevent scratching during transport.

Please peel off the film before installing the casing parts. It can be removed without tools.

Dismantling

If the hood needs to be disassembled, follow the instructions on the "Installation diagram" in the reverse order.

A lever is enclosed for easier removal of the chimney extension.

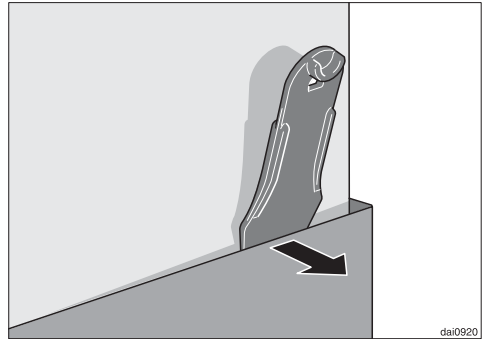

- After removing the two screws from the chimney, slide the lever between the chimney and the chimney extension and gently apply pressure to ease the chimney from its hooks.

Installation

Installation material

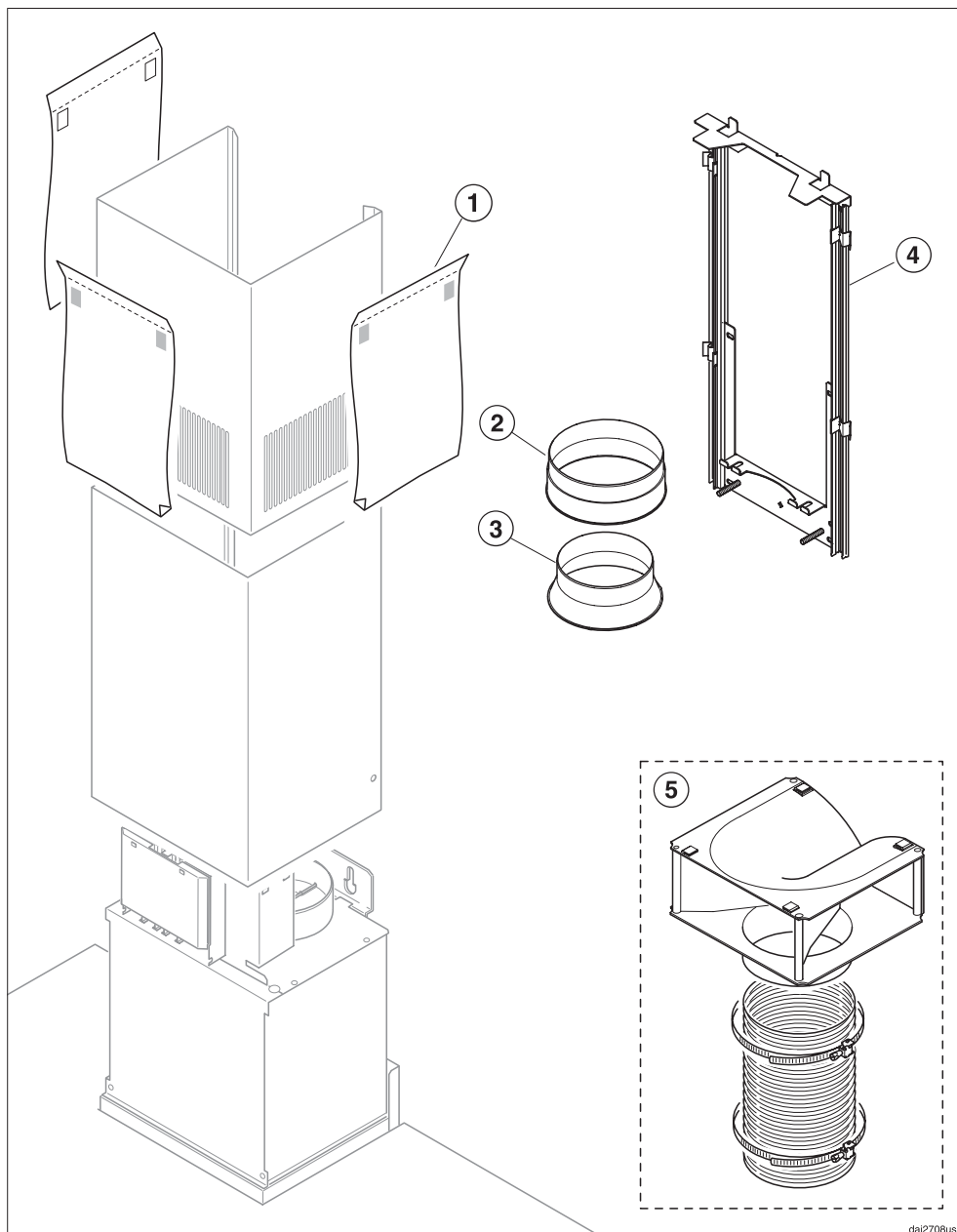

① **3 protective shields**

to prevent scratches to the chimney during installation.

② **1 vent collar**

for use with 6" (150 mm) exhaust ducting.

③ **1 vent pipe adapter**

for use with 5" (125 mm) exhaust ducting.

④ **Telescopic retaining plate** to secure the ventilation hood to the wall.

⑤ **Installation kit for recirculation mode**

contains diverter, hose and hose clips (optional accessory, see "Technical data").



6 Screws 5 x 40 mm

(S8 wall anchors included in the packaging are not for use in USA / CDN)

 The screws and wall anchors are suitable for solid brick walls. For other wall constructions, use appropriate materials. Ensure that the wall can support the weight.



2 M 6 locking nuts

for securing the motor assembly.



2 Screws 3.9 x 7.5 mm

for securing the chimney.

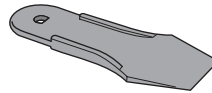

1 Lever

for dismantling the chimney.

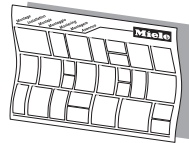

Installation instructions

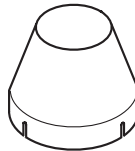

Reducing collar

(optional accessory)

See "Reducing Collar" for more information.

Air extraction

WARNING

Danger of toxic fumes.

Gas cooking appliances release carbon monoxide that can be harmful or fatal if inhaled.

To reduce the risk of fire and to properly exhaust air, the exhaust gases extracted by the hood should be vented outside of the building only.

Do not vent exhaust air into spaces within walls or ceilings or in attics, crawl spaces or garages.

To reduce the risk of fire, only use metal ductwork.

Please read and follow the **"IMPORTANT SAFETY INSTRUCTIONS"** to reduce the risk of personal injury. Follow all local building codes when installing the hood.

Exhaust ducting and connections

Use smooth or flexible pipework made from approved non-flammable materials for exhaust ducting.

To achieve the most efficient air extraction and quietest noise levels, consider the following:

- The diameter of the ductwork should not be less than 6" (150 mm).
- If flat ducting is used, the cross section must not be smaller than the cross section of the ventilation exhaust.
- The ducting should be as short and straight as possible.
- Use ductwork with a wide radius.
- The exhaust duct must not be bent or compressed.
- Make sure all connections are secure.
- Where the ductwork is horizontal, it must slope away from the hood at least $\frac{1}{8}$ " per foot (1 cm per meter) to prevent condensation dripping into the appliance.
- If the exhaust is ducted through an outside wall, a Telescopic Wall Vent can be used.

- If the exhaust is ducted into an inactive flue, the air must be expelled parallel to the flow direction of the flue.

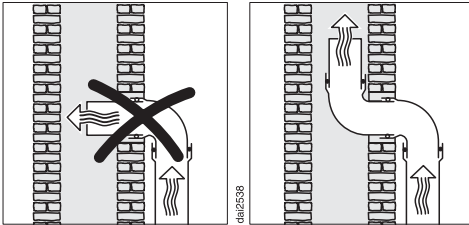

Never connect an exhaust hood to an active chimney, dryer vent, flue, or room venting ductwork. Seek professional advice before connecting an exhaust hood vent to an existing, inactive chimney or vent flue.

Important

If the ductwork runs through rooms, ceilings, garages, etc. where temperature variations exist, it may need to be insulated to reduce condensation.

Air extraction

Reducing Collar

(optional accessory)

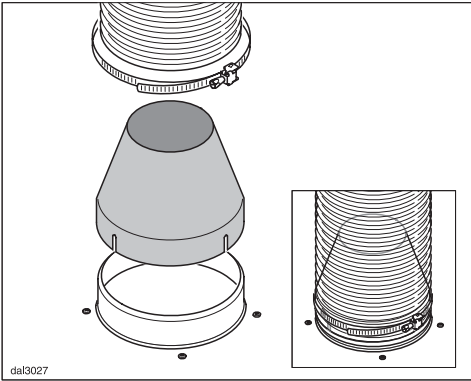

If you would like to reduce the environmental impact of your ventilation system by limiting the CFM output the Reducing Collar can be installed.

It reduces the air flow to less than 400 CFM.

Check local building codes for max. CFM requirements.

- Push the Reducing Collar on the exhaust port of the fan.
- Push the exhaust hose over it.
- Fix both with a hose clamp.

Condensate trap

(optional accessory)

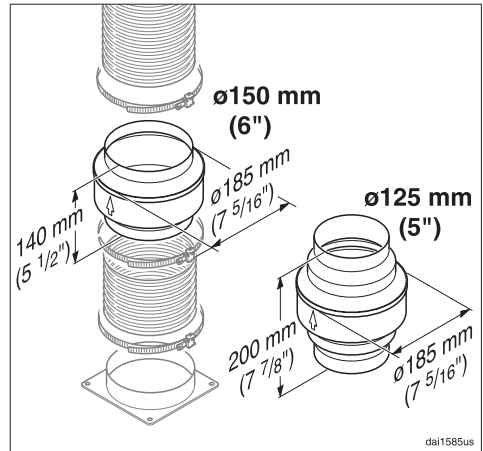

In some cases, a condensate trap may also be required to collect and evaporate any condensate which may occur. This optional accessory is available for ducts 5" (125 mm) and 6" (150 mm) in diameter.

When installing a condensate trap, ensure that it is positioned vertically and if possible directly above the exhaust outlet.

⚠ WARNING
TO REDUCE THE RISK OF
FIRE, ELECTRIC SHOCK, OR
INJURY TO PERSONS,
OBSERVE THE FOLLOWING:

All electrical work should be performed by a qualified electrician in strict accordance with national regulations (for USA: ANSI-NFPA 70) and local safety regulations. Installation, repairs and other work by unqualified persons could be dangerous. Ensure that power to the appliance is OFF while installation or repair work is performed.

- Verify that the voltage, load and circuit rating information found on the data plate (located behind the grease filters), match the household electrical supply before installing the hood.
- Use only with ventilation hood cord-connection kits that have been investigated and found acceptable for use with this model hood.

If there is any question concerning the electrical connection of this appliance to your power supply, please consult a licensed electrician or call Miele's Technical Service Department.

⚠ WARNING:
THIS APPLIANCE MUST BE
GROUNDED

Grounding Instructions

This appliance must be grounded. In the event of an electrical short circuit, grounding reduces the risk of electric shock by providing a path of least resistance. This appliance is equipped with a cord having a grounding wire with a grounding plug. The plug must be plugged into an outlet that is properly installed and grounded.

WARNING - Improper grounding can result in a risk of electric shock.

If there is any doubt, have the electrical system of the house checked by a qualified electrician.

Do not use an extension cord. If the power supply cord is too short, have a qualified electrician install an outlet near the appliance.

Important

The hood comes equipped with a 6.5 ft (2 m) power cord with a NEMA 5-15 molded plug for connection to a 120 VAC, 60 Hz, 15 A power outlet.

Technical data

Total connected load * 410 W
– Fan motor * 350 W
– Overhead light 3 x 20 W
Voltage 120 V AC
Frequency 60 Hz
Fuse rating 15 A
Length of the
power cord 6.5 ft (2 m)
Weight
DA 6590 W 46 lbs (21 kg)

**Optional accessories for
recirculation (DA 6590 W only):**

- **DUW 20 conversion kit**
- **Miele DKF 12-1 active carbon filter**

Please have the model and serial number of your appliance available before contacting Technical Service.

The Miele logo is displayed in a bold, white, sans-serif font against a solid black rectangular background.

U.S.A. Miele, Inc.

National Headquarters

9 Independence Way
Princeton, NJ 08540
Phone: 800-843-7231
609-419-9898
Fax: 609-419-4298
www.mieleusa.com

Technical Service & Support Nationwide

Phone: 800-999-1360
Fax: 888-586-8056

TechnicalService@mieleusa.com

Canada Miele Limited

Headquarters and Showroom

161 Four Valley Drive
Vaughan, ON L4K 4V8
Phone: 800-643-5381
Fax: 905-532-2290
www.miele.ca
professional@miele.ca
(commercial enquiries)

MieleCare National Service

Phone: 800-565-6435
905-532-2272
Fax: 905-532-2292
customercare@miele.ca
(general and technical enquiries)



www.miele-shop.com

